

0	1	2	3	4	5	6	7	8	9
SECTION	DESCRIZIONE	DESCRIPTION	D	F	COD. / PAGE No.				
01	COPERTINA	COPERTINA	-	-	1 - 2				
02	ALIMENTAZIONE POTENZA E SERVIZI AUSILIARI	POWER SUPPLY & AUXILIARY SERVICES	-	-	1				
03	LINEA POTENZA COMPRESSORI	COMPRESSOR POWER SUPPLY	-	-	2				
04	LINEA POTENZA VENTILATORI	FAN POWER SUPPLY	-	-	3				
05	LINEA POTENZA POMPE	PUMPS POWER SUPPLY	-	-	4				
06	SERVIZI AUSILIARI	AUXILIARY SERVICES	-	-	5				
07	MICROPROCESSORE - INGRESSI DIGITALI	MICROPROCESSOR - DIGITAL INPUT	-	-	6				
08	MICROPROCESSORE - INGRESSI ANALOGICI	MICROPROCESSOR - ANALOGUE INPUT	-	-	7				
09	MICROPROCESSORE - USCITE DIGITALI	MICROPROCESSOR - DIGITAL OUTPUT	-	-	8				
10	MICROPROCESSORE - USCITE ANALOGICHE	MICROPROCESSOR - ANALOGUE OUTPUT	-	-	9				
11	DRIVER VALVOLA ESPANSIONE ELETTRONICA	ELECTRONIC EXPANSION VALVE DRIVER	-	-	10				
12	COLLEGAMENTI CLIENTE	USER CONNECTIONS	-	-	11				
13	TOPOGRAFICO SCHEDE MICROPROCESSORE	TOPOGRAPHIC MICROPROCESSOR CARD	-	-	12				
14	TOPOGRAFICO QUADRO ELETTRICO	ELECTRIC SWITCHBOARD LAYOUT	-	-	13				
15	LISTA COMPONENTI	COMPONENTS LIST	-	-	14				
16	LEGENDA	LEGEND	-	-	15				

REV A	Modification FIRST ISSUE	Model: IP-IN/ST/AS 151	ELENCO SEZIONI / SECTIONS LIST D / F		SECTION 01
06/09/2018	Drafter SF	Approved AC	Drawing no.: 85505180/001		SHEET 2
			File name: 85505180-001-A		
			DRAFT.: SF	DATE: 06/09/2018	

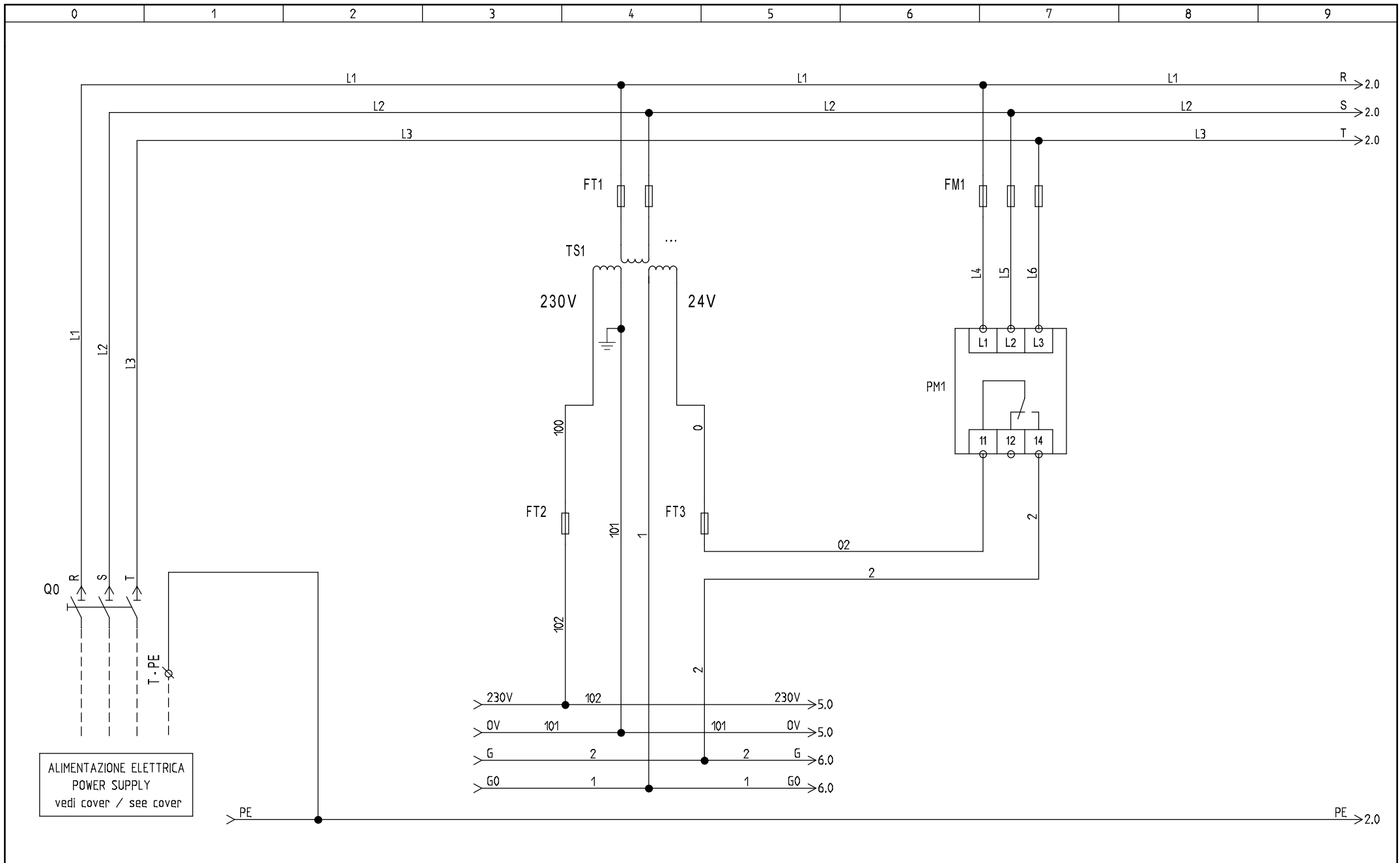

REV A	Modification FIRST ISSUE	Model: IP-IN/ST/AS 151	ALIMENTAZ. POTENZA E SERV.AUSILIARI/POWER SUPPLY & AUXILIARY SERVICES - / -	SECTION 02
06/09/2018	Drafter SF	Approved AC	File name: 85505180-001-A DRAFT.: SF	SHEET 1
DATE: 06/09/2018				

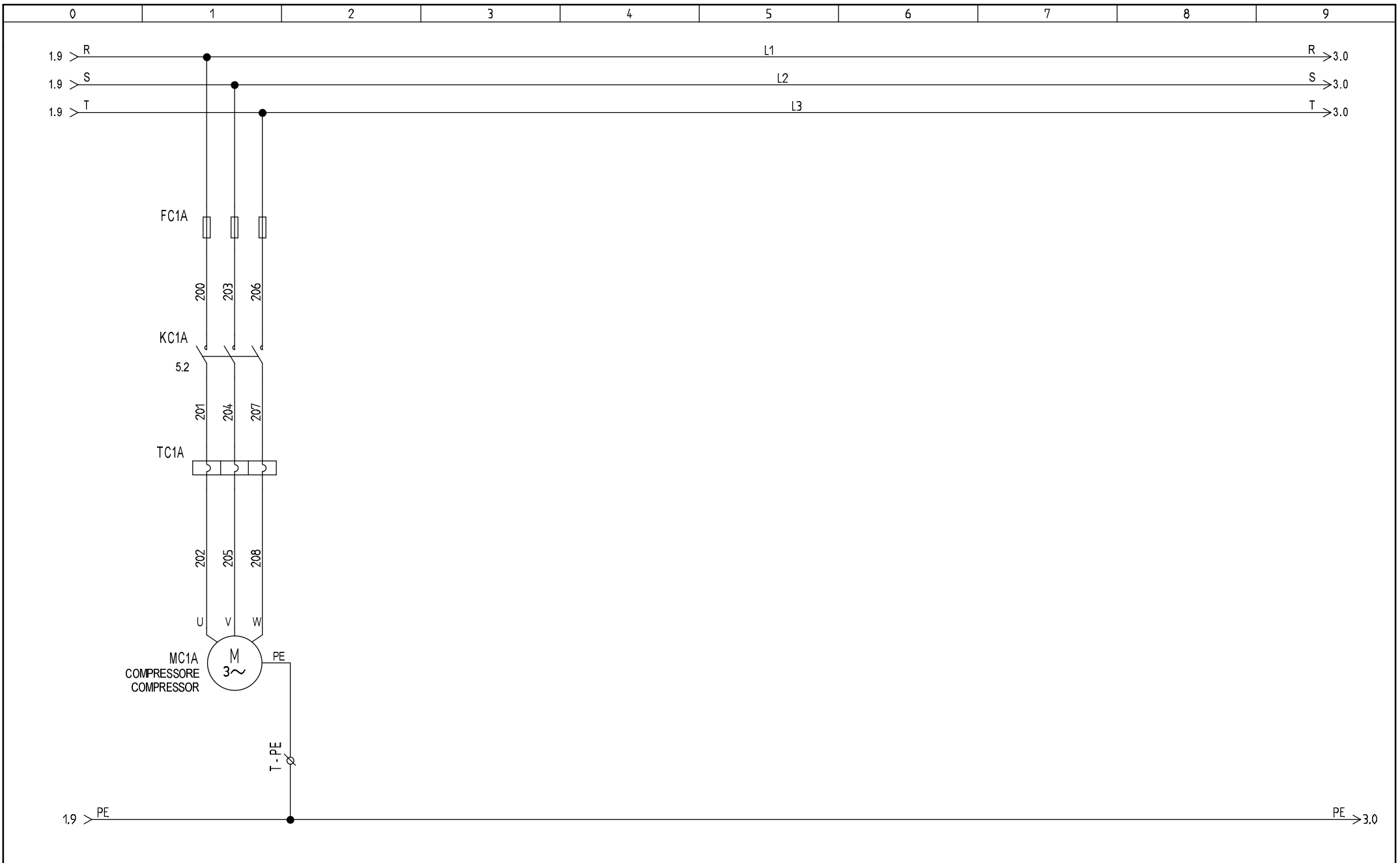

REV A	Modification FIRST ISSUE	Model: IP-IN/ST/AS 151	LINEA POTENZA COMPRESSORI / COMPRESSOR POWER SUPPLY	SECTION 03
06/09/2018	Drafter SF	Approved AC	DRAFT.: SF	SHEET 2
		Drawing no.: 85505180/001	File name: 85505180-001-A	DATE: 06/09/2018

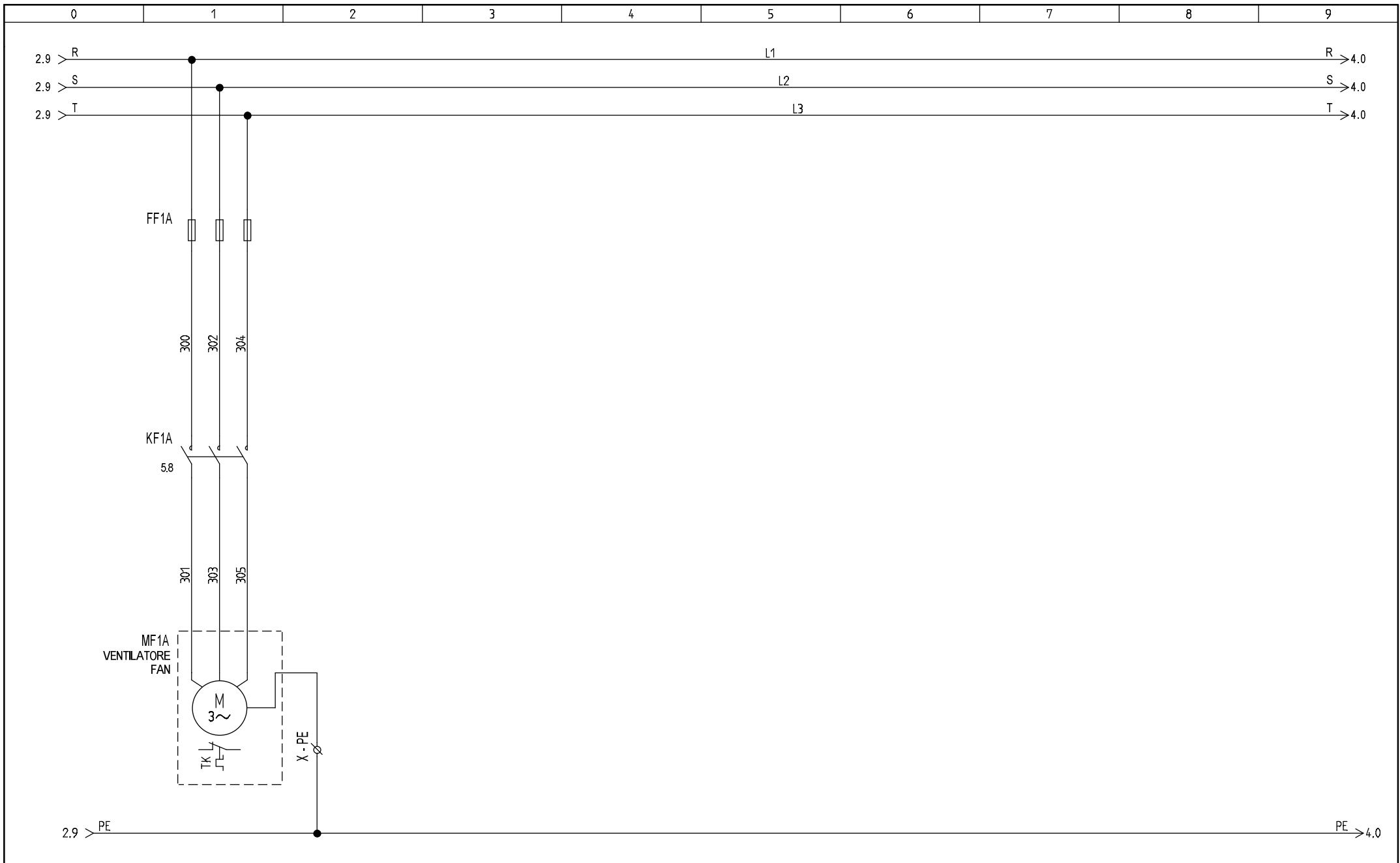

REV A	Modification FIRST ISSUE	Model: IP-IN/ST/AS 151	LINEA POTENZA VENTILATORI / FAN POWER SUPPLY	SECTION 04
06/09/2018	Drafter SF	Approved AC	Drawing no.: 85505180/001	File name: 85505180-001-A
			DRAFT.: SF	DATE: 06/09/2018
				SHEET 3

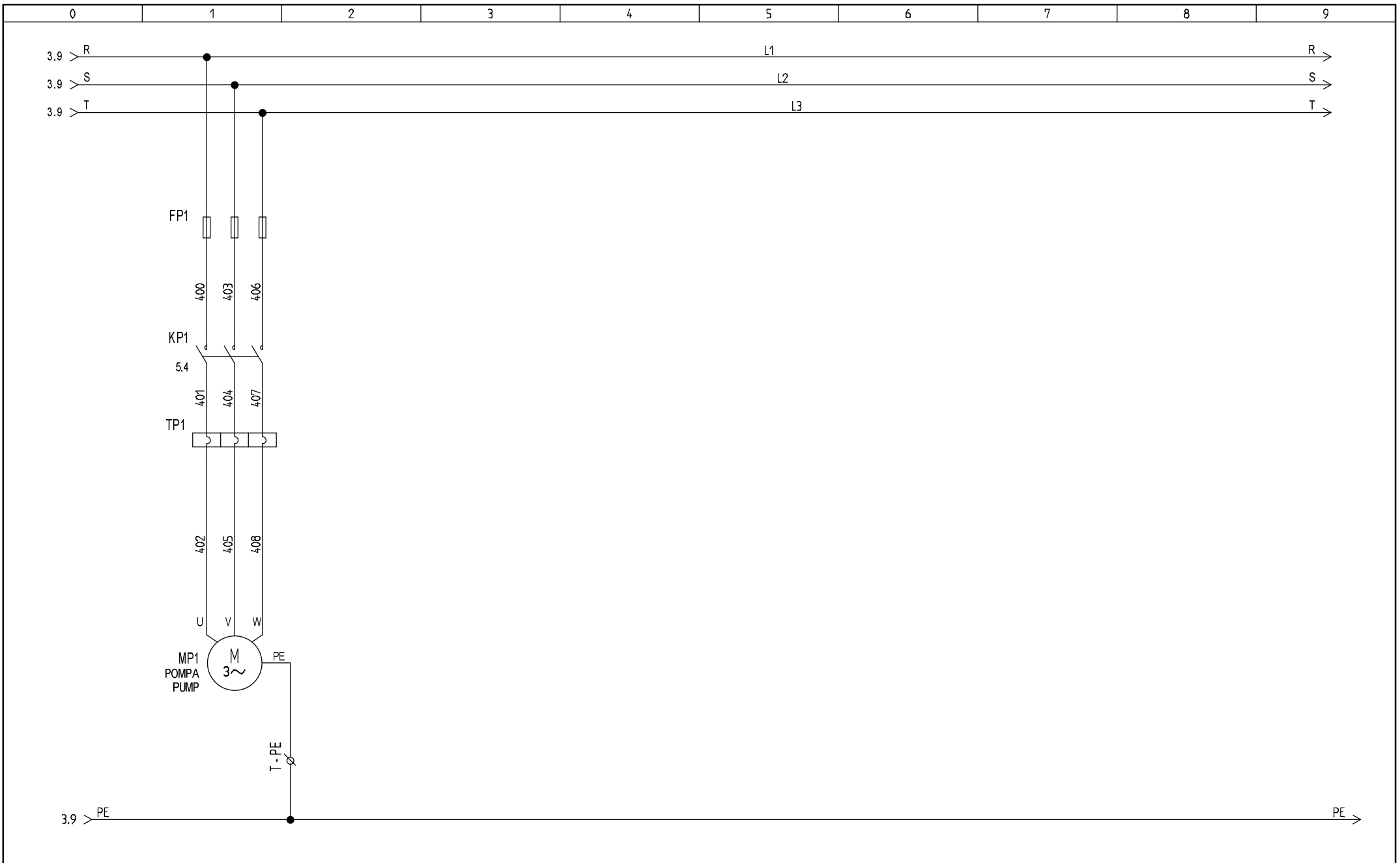

REV A	Modification FIRST ISSUE	Model: IP-IN/ST/AS 151	LINEA POTENZA POMPA / PUMP POWER SUPPLY	SECTION 05
06/09/2018	Drafter SF	Approved AC	Drawing no.: 85505180/001	SHEET 4
			File name: 85505180-001-A	
			DRAFT.: SF	DATE: 06/09/2018

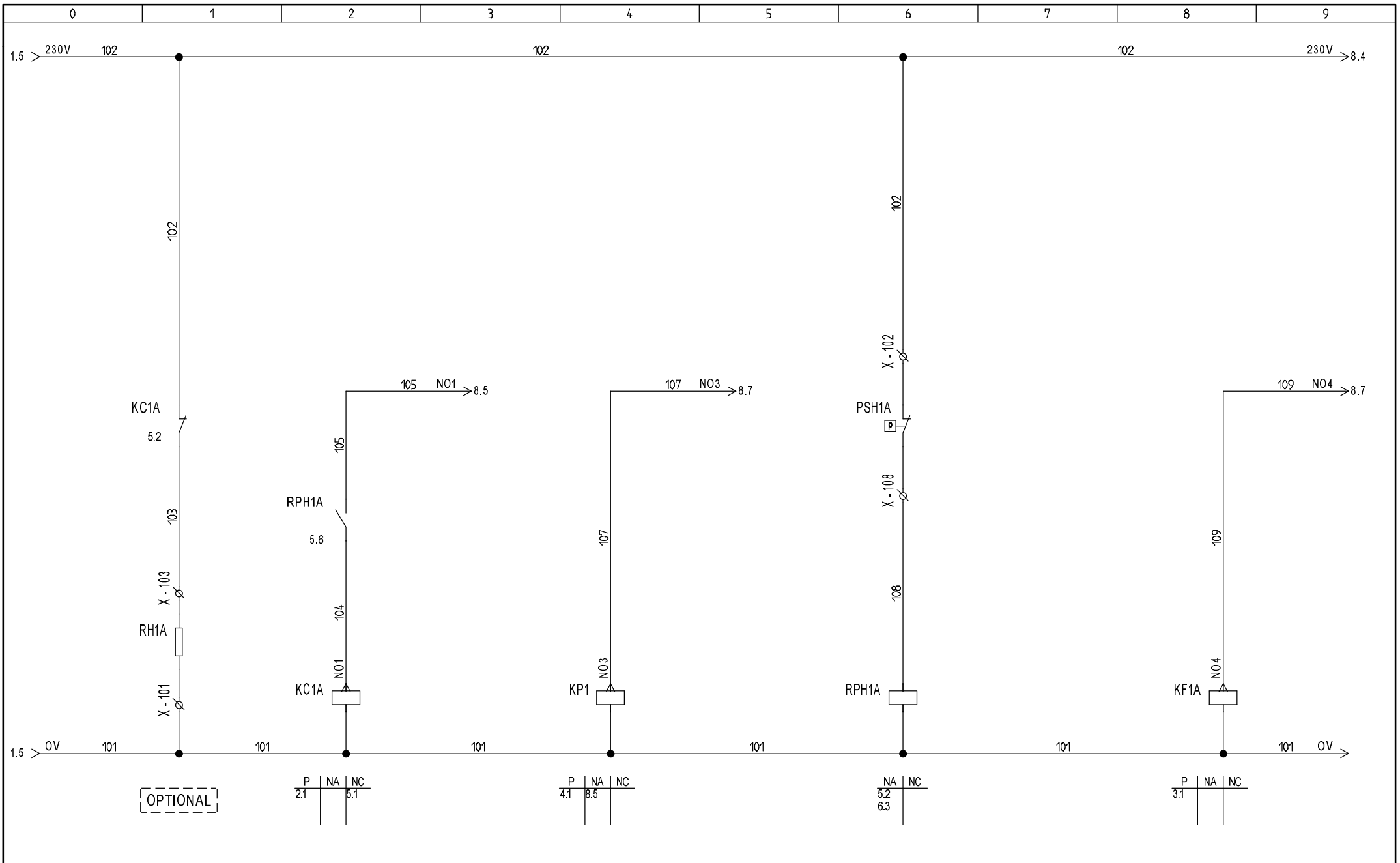

REV A	Modification FIRST ISSUE	Model: IP-IN/ST/AS 151	SERVIZI AUSILIARI / AUXILIARY SERVICES	SECTION 06
06/09/2018	Drafter SF	Approved AC	Drawing no.: 85505180/001	SHEET 5
			File name: 85505180-001-A	
			DRAFT.: SF	DATE: 06/09/2018

GO	B1	B2	B3	ID5	ID3	ID1
G	GND	GND	Y	GND	ID4	ID2

MICROCHILLER 2
Second Edition

NO1	C1/2	C1/2	C3/4	X	C5
NO2	NO3	NO4	C3/4	X	NO5

INPUT CONNECTOR

OUTPUT CONNECTOR

RS485

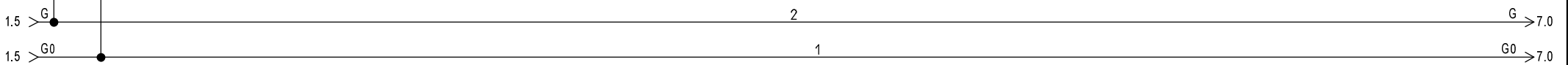
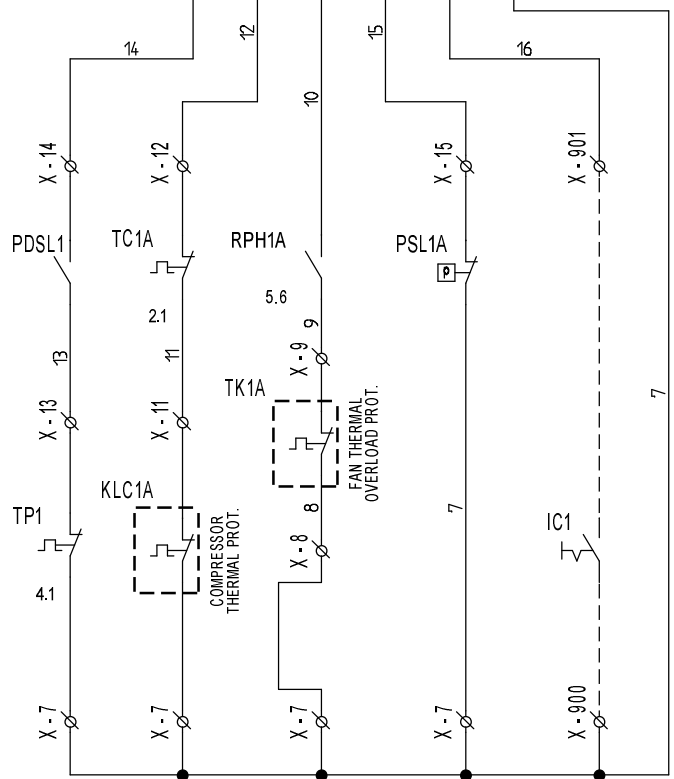
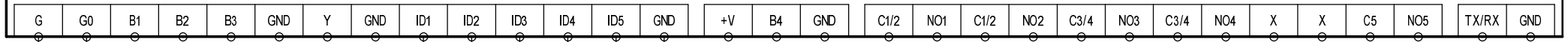

REV A	Modification FIRST ISSUE	Model: IP-IN/ST/AS 151	INGRESSI DIGITALI MICROPROCESSORE / MICROPROCESSOR DIGITAL INPUT	SECTION 07
06/09/2018	Drafter SF	Approved AC	File name: 85505180-001-A	SHEET 6
		Drawing no.: 85505180/001	DRAFT.: SF	DATE: 06/09/2018

MCH1

GO	B1	B2	B3	ID5	ID3	ID1
G	GND	GND	Y	GND	ID4	ID2

MICROCHILLER 2
Second Edition

NO1	C1/2	C1/2	C3/4	X	C5
NO2	NO3	NO4	C3/4	X	NO5

INPUT CONNECTOR

OUTPUT CONNECTOR

RS485

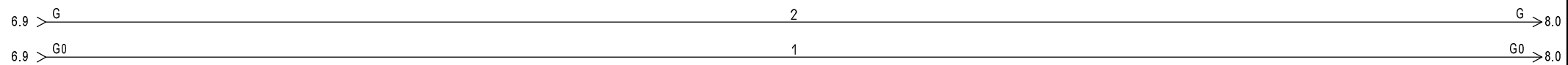
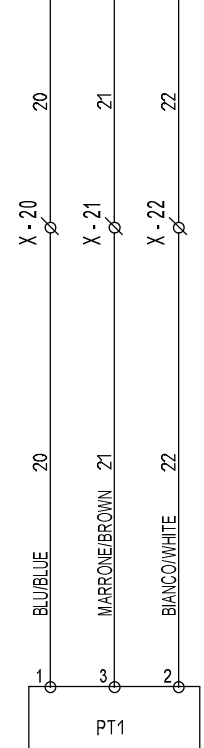
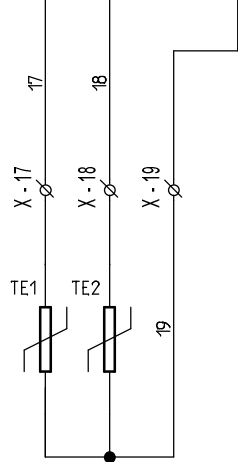
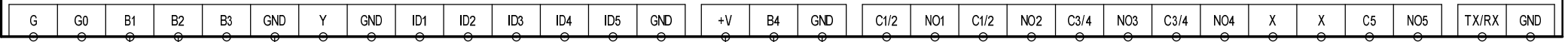

REV A	Modification FIRST ISSUE	Model: IP-IN/ST/AS 151	INGRESSI ANALOGICI MICROPROCESSORE / MICROPROCESSOR ANALOGUE INPUT	SECTION 08
06/09/2018	Drafter SF	Drawing no.: 85505180/001	File name: 85505180-001-A	SHEET 7
	Approved AC		DRAFT.: SF	DATE: 06/09/2018

GO	B1	B2	B3	ID5	ID3	ID1
G	GND	GND	Y	GND	ID4	ID2

MICROCHILLER 2
Second Edition

NO1	C1/2	C1/2	C3/4	X	C5
NO2	NO3	NO4	C3/4	X	NO5

INPUT CONNECTOR

OUTPUT CONNECTOR

RS485

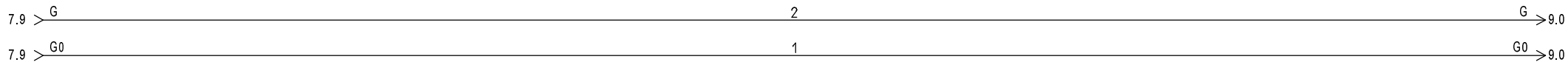
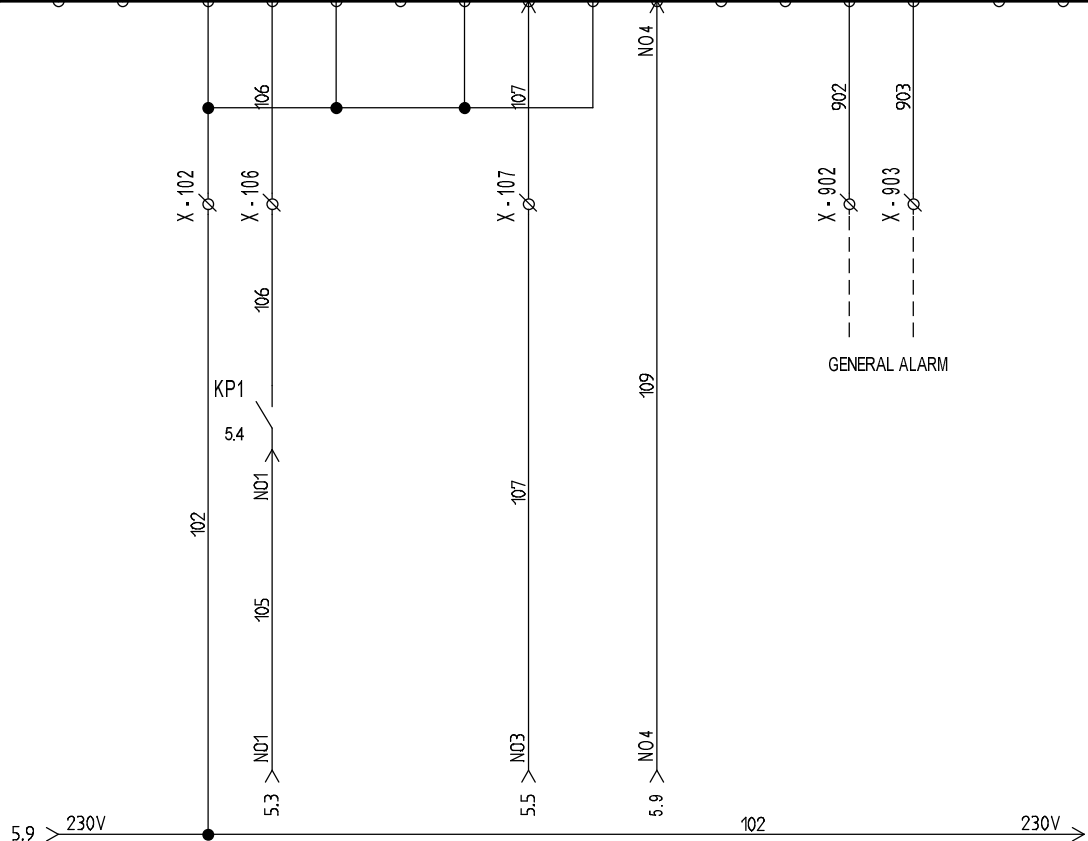
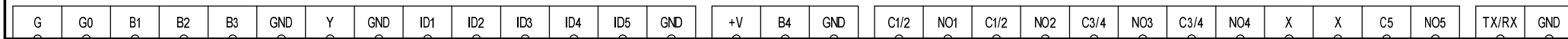

REV A	Modification FIRST ISSUE	Model: IP-IN/ST/AS 151	USCITE DIGITALI MICROPROCESSORE / MICROPROCESSOR DIGITAL OUTPUT	SECTION 09
06/09/2018	Drafter SF	Approved AC	Drawing no.: 85505180/001	SHEET 8
			File name: 85505180-001-A	
			DRAFT.: SF	DATE: 06/09/2018

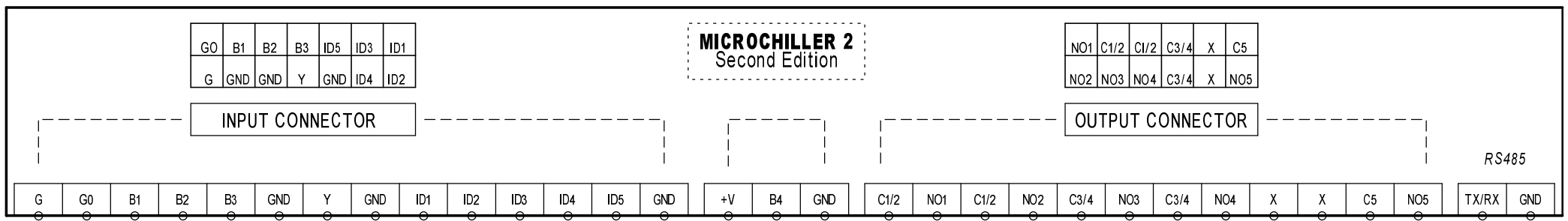

INTENTIONALLY BLANK

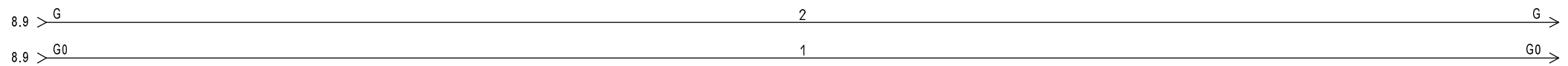

REV A	Modification FIRST ISSUE	Model: IP-IN/ST/AS 151	USCITE ANALOGICHE MICROPROCESSORE / MICROPROCESSOR ANALOGUE OUTPUT	SECTION 10
06/09/2018	Drafter SF	Approved AC	Drawing no.: 85505180/001	SHEET 9
			File name: 85505180-001-A	
			DRAFT.: SF	DATE: 06/09/2018

0

1

2

3

4

5

6

7

8

9

INTENTIONALLY BLANK

REV A	Modification FIRST ISSUE	Model: IP-IN/ST/AS 151	DRIVER VALVOLA ESP. ELETTRONICA / ELECTRONIC EXP. VALVE DRIVER	SECTION 11
06/09/2018	Drafter SF	Approved AC	Drawing no.: 85505180/001	File name: 85505180-001-A
			DRAFT.: SF	DATE: 06/09/2018
				SHEET 10

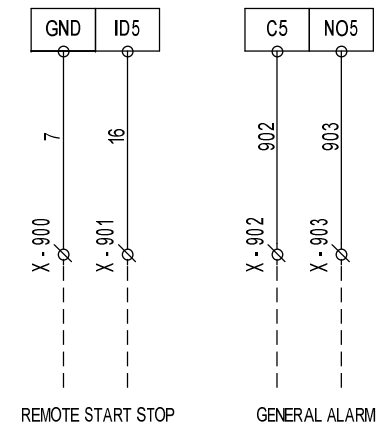

REV

A

Modification
FIRST ISSUE

Model: IP-IN/ST/AS 151

CONNESSIONI CLIENTE / USER CONNECTION

SECTION 12

Drawing no.: 85505180/001

06/09/2018

Drafter SF
Approved AC

File name: 85505180-001-A

DRAFT.: SF

DATE: 06/09/2018

SHEET 11

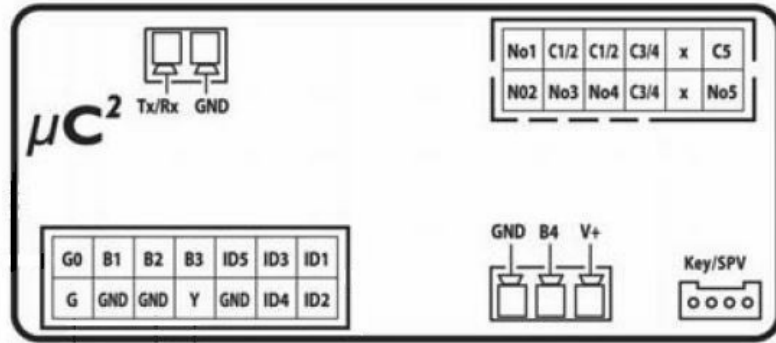
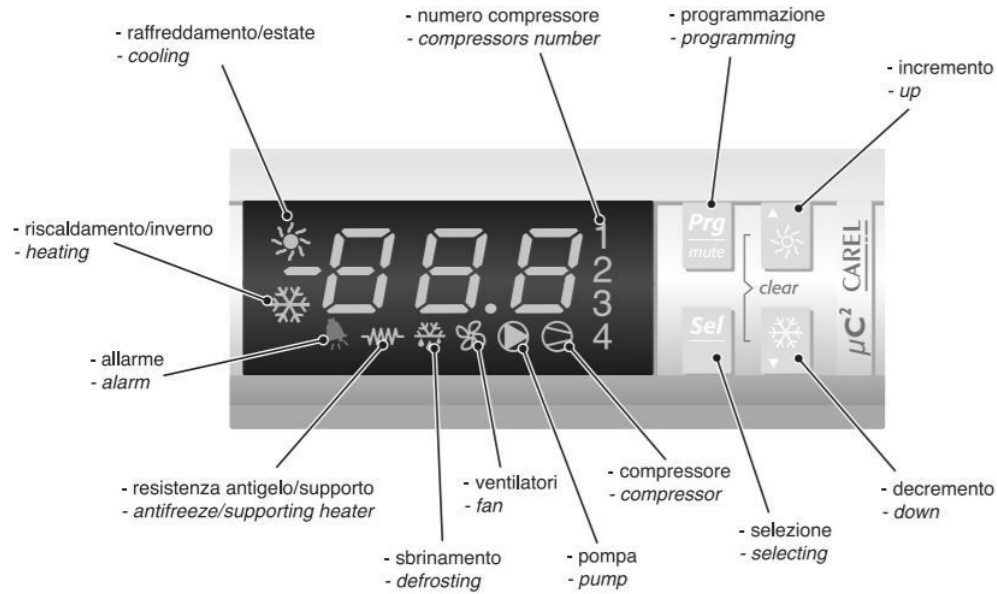

REV A	Modification FIRST ISSUE	Model: IP-IN/ST/AS 151	TOPOGRAFICO SCHEDA MICROPROCESSORE / MICROPROCESSOR LAYOUT	SECTION 13
06/09/2018	Drafter SF	Drawing no.: 85505180/001	File name: 85505180-001-A	SHEET 12
	Approved AC		DRAFT.: SF	DATE: 06/09/2018

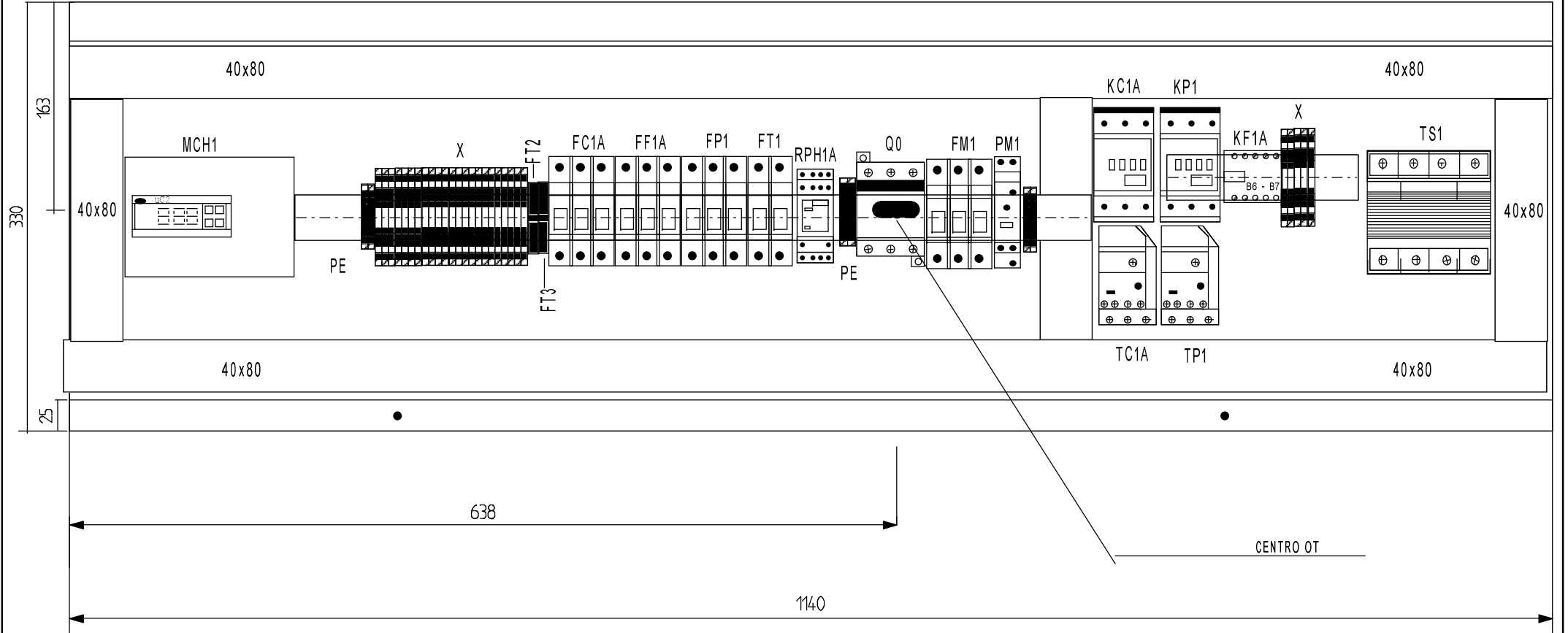

REV A	Modification FIRST ISSUE
06/09/2018	Drafter SF Approved AC

Model: IP-IN/ST/AS 151
 Drawing no.: 85505180/001











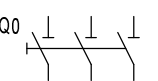

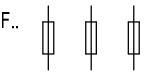

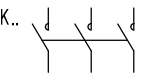

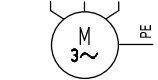

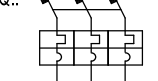

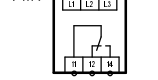
TOPOGRAFICO QUADRO ELETTRICO / ELECTRIC SWITCHBOARD LAYOUT	
File name:	85505180-001-A
DRAFT:	SF DATE: 06/09/2018

SECTION	14
SHEET	13

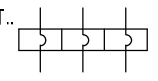
0	1	2	3	4	5	6	7	8	9		
ITEM	DESCRIPTION / MODEL	Power Supply	Max Power	FLA	LRA	CIRCUIT BREAKER	CONTACTOR	FUSES	THERMAL RELAY	Wires Type Elect. Switchboard	Wires Type On field
COMPRESSORE/COMPRESSOR/VERDICHTER/COMPRESSEUR			[kW]	[A]	[A]	Model - [A]	Model - [A]	Model - [A]	Model - [A]	Model + mmq	Model + mmq
MC1A	C-SCP400H38B	400V/3Ph/50Hz	13.8	22.2	102.0	-	AF26-3000 13	PMX10-3 - 32A-AM	TF42 - 24	4 mmq	FG16 - 4G2,5
-	-	-	-	-	-	-	-	-	-	-	-
-	-	-	-	-	-	-	-	-	-	-	-
-	-	-	-	-	-	-	-	-	-	-	-
VENTILATORI COND./CONDENSER FANS/LÜFTER VERFLÜSSIGER											
MF1A	A6D710AQ0101-106AS0650	400V/3Ph/50Hz	0.84	1.74	-	-	B6 30 10 84	PMX10-3 - 2A-AM	-	1,5 mmq	FG16 - 4G1,5
-	-	-	-	-	-	-	-	-	-	-	-
-	-	-	-	-	-	-	-	-	-	-	-
-	-	-	-	-	-	-	-	-	-	-	-
-	-	-	-	-	-	-	-	-	-	-	-
-	-	-	-	-	-	-	-	-	-	-	-
POMPA/PUMP/PUMPE/POMPE											
MP1	CDXH/I 200/20 C/C/VITON	400V/3Ph/50Hz	1.5	4.1	-	-	AF12 30 10 13	PMX10-3 - 6A-AM	TF42 - 4,2	1,5 mmq	FG16 - 4G1,5
-	-	-	-	-	-	-	-	-	-	-	-
-	-	-	-	-	-	-	-	-	-	-	-

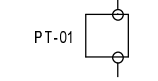
ITEM	DESCRIPTION	MODEL
Q0	SEZIONATORE GENERALE / MAIN SWITCH	OT 63 F 3
FT1	FUSIBILE TRASFORMATORE / TRANSFORMER FUSES	PMX 12-2 + FUSIBILE 10x38 2A - AM WIMEX
TS1	TRASFORMATORE SERVIZI AUSILIARI / AUX. SERVICES TRANSFORMER	150 VA 1TC 150 - 043 - 1 ESME
FT2	FUSIBILE TRASFORMATORE / TRANSFORMER FUSES	SF 900 GR + FUSIBILE 5x20 2A - AM CABUR
FT3	FUSIBILE TRASFORMATORE / TRANSFORMER FUSES	SF 900 GR + FUSIBILE 5x20 2A - AM CABUR
FM1	FUSIBILE RELE' SEQUENZA FASI / SEQUENCE PHASE RELAY FUSES	PMX 10-3 + FUSIBILE 10x38 1A - F WIMEX
PM1	RELE' SEQUENZA FASI / SEQUENCE PHASE RELAY	70.61.8.400.0000 FINDER
RPH1A	RELE' / RELAY	55.34.8.230.0040 + 98.84.2 FINDER
CT1A	CONVERTITORE SEGNALE / SIGNAL CONVERTER	

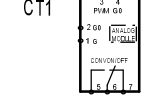
REV A	Modification FIRST ISSUE	Model: IP-IN/ST/AS 151	TOPOGRAFICO QUADRO ELETTRICO / ELECTRIC SWITCHBOARD LAYOUT	SECTION 15
06/09/2018	Drafter SF	Approved AC	Drawing no.: 85505180/001	SHEET 14
			File name: 85505180-001-A	
			DRAFT.: SF	DATE: 06/09/2018

0	1	2	3	4	5	6	7	8	9
	SEZIONATORE GENERALE MAIN SWITCH		PRESSOSTATO PRESSURE SWITCH	Item MC1A	Description MOTORE COMPRESSORE CIRCUITO 1 CIRCUIT 1 COMPRESSOR MOTOR	Symbol -- -- -- --	Description -- -- -- --		
	FUSIBILI FUSES		SELETTORE 0-1 0-1 SELECTOR	Item MV1A	Description MOTORE VENTILATORE CIRCUITO 1 CIRCUIT 1 FAN MOTOR	Symbol -- -- -- --	Description -- -- -- --		
	CONTATTORE CONTACTOR		TRASFORMATORE SERVIZI AUS. AUX TRANSFORMER	Item MP1	Description MOTORE POMPA: 1-2(USER)/3(RECIRC.) PUMP MOTOR:1-2(USER)/3 (RECIRC.)	Symbol -- -- -- --	Description -- -- -- --		
	MOTORE TRIFASE 3 PHASE MOTOR		SONDA TEMPERATURA NTC NTC TEMPERATURE PROBE	Item PSH1A	Description PRESSOSTATO ALTA PRESSIONE HIGH PRESSURE SWITCH	Symbol -- -- -- --	Description -- -- -- --		
	INTERRUPTORE MAGNETOTERMICO CIRCUIT BREAKER		PRESSOSTATO DIFFERENZIALE DIFFERENTIAL PRESSURE SWITCH	Item PSL1A	Description PRESSOSTATO BASSA PRESSIONE LOW PRESSURE SWITCH	Symbol -- -- -- --	Description -- -- -- --		
	RELE' SEQUENZA FASE SEQUENCE PHASE RELAY		INTERRUPTORE AUSILIARIO RELE' TERMICO CIRCUIT BREAKER AUXILIARY RELAY	Item FL1	Description FLUSSOSTATO FLOW SWITCH	Symbol -- -- -- --	Description -- -- -- --		
	KLIXON VENTILATORE KLIXON FAN MOTOR THERMAL SWITCH		RESISTENZA RESISTANCE	Item --	Description -- -- -- --	Symbol -- -- -- --	Description -- -- -- --		
	RELE' TERMICO / THERMAL RELAY RELE' TERMICO / THERMAL RELAY		CONTATTORE, RELE' AUSILIARIO CONTACTOR, AUX RELAY	Item --	Description -- -- -- --	Symbol -- -- -- --	Description -- -- -- --		
	TRASDUTTORE DI PRESSIONE PRESSURE TRANSDUCER		VALVOLA A SOLENOIDE SOLENOID VALVE	Item --	Description -- -- -- --	Symbol -- -- -- --	Description -- -- -- --		
	CONVERTITORE DI SEGNALE SIGNAL CONVERTER		TRASDUTTORE DI PRESSIONE PRESSURE TRANSDUCER	Item --	Description -- -- -- --	Symbol -- -- -- --	Description -- -- -- --		

REV A	Modification FIRST ISSUE	Model: IP-IN/ST/AS 151	TOPOGRAFICO QUADRO ELETTRICO / ELECTRIC SWITCHBOARD LAYOUT	SECTION 16
06/09/2018	Drafter SF	Approved AC	Drawing no.: 85505180/001	File name: 85505180-001-A
			DRAFT.: SF	DATE: 06/09/2018
				SHEET 15